

Historic, archived document

Do not assume content reflects current scientific knowledge, policies, or practices

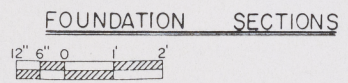
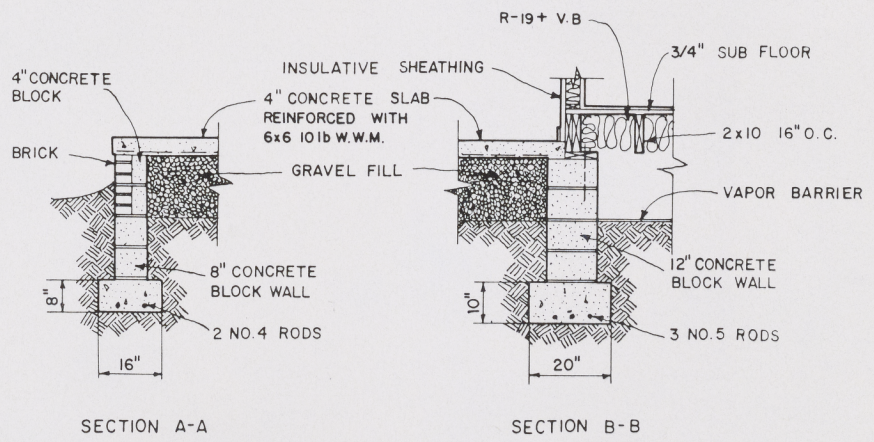
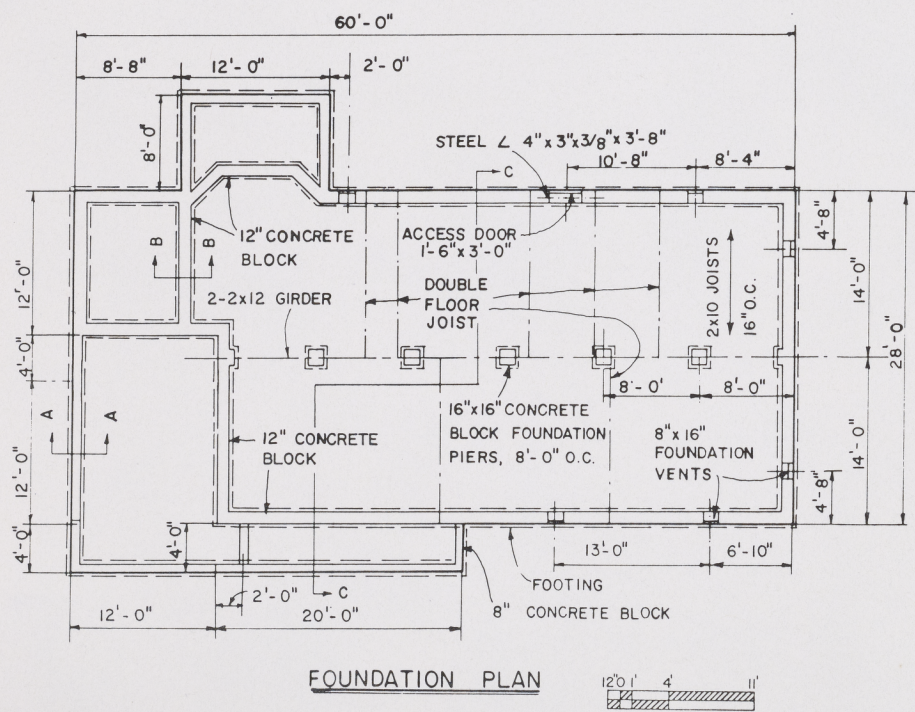
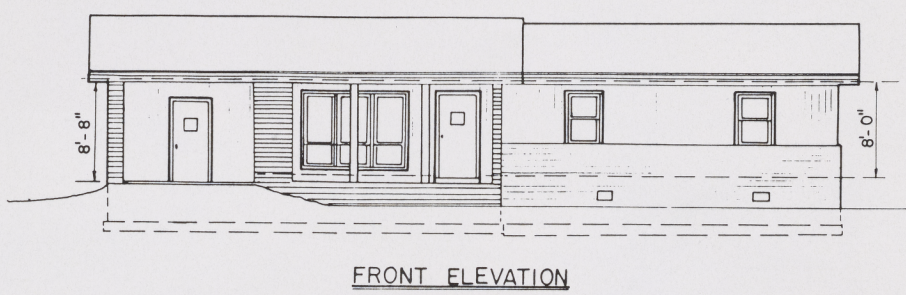
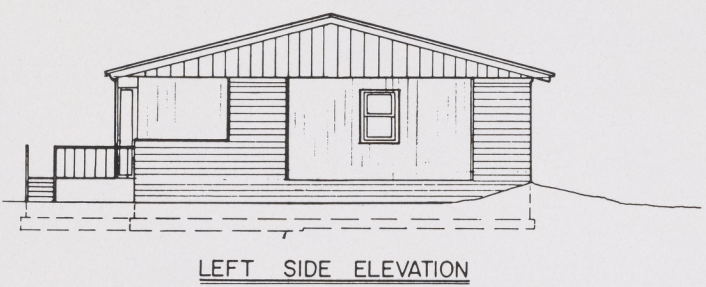
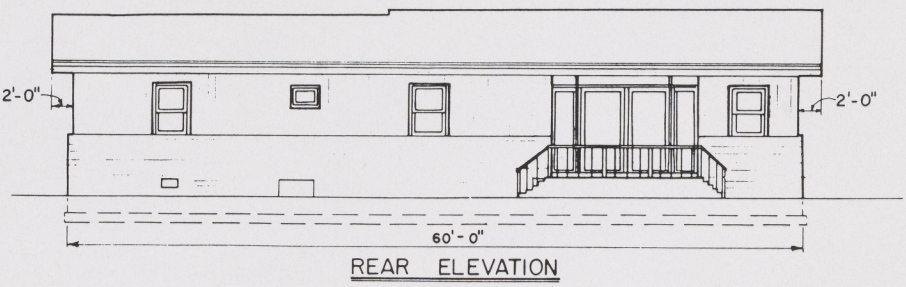
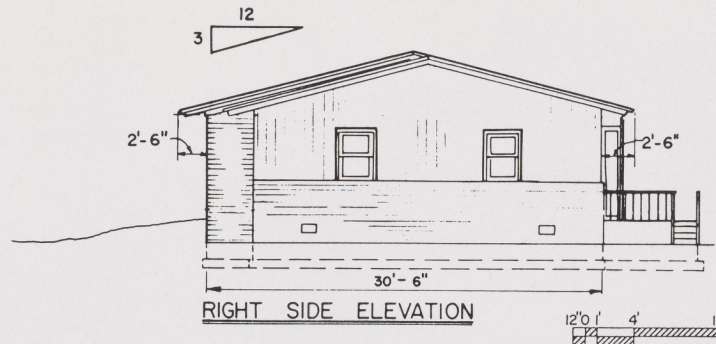

COOPERATIVE EXTENSION SERVICE AGRICULTURE AND HOME ECONOMICS		
UNITED STATES DEPARTMENT OF AGRICULTURE COOPERATING		
4-BEDROOM RURAL DWELLING		
ARK. '69	7184	SHEET 2 OF 3
REV. '86		

CONSTRUCTION CHECK LIST

1. CHECK LOCAL BUILDING CODE AND LOAN COMPANY CRITERIA, PURCHASE TRUSSES TO MEET LOCAL SNOW LOAD CRITERIA. (2-2x12 BEAM DESIGNED FOR 25 lb/ft² TOTAL LOAD).
2. ADEQUATELY NAIL AND ANCHOR JOINTS.
3. DOUBLE JOISTS UNDER TUBS AND OTHER HEAVY LOADS.
4. SHEATH CORNERS WITH 1/2" PLYWOOD OR HIGH DENSITY FIBERBOARD OR USE DIAGONAL BRACING.
5. USE EXTERIOR GLUED PLYWOOD WHEREVER IT MAY BE WETTED DURING OR AFTER CONSTRUCTION.
6. PRESSURE TREAT ALL WOOD WITH GROUND CONTACT AND PROVIDE OTHER NEEDED TERMITE CONTROL.
7. R VALUES DEPEND ON LOCAL CLIMATE AND FUEL COSTS.
8. PROVIDE 1 SQ FT OF ATTIC VENT OPENINGS FOR EACH 150 SQ FT OF CEILING.
9. WEATHERIZE ALL OPENINGS AND JOINTS.

235 lb ASPHALT SHINGLES OVER 15 lb BUILDING PAPER AND 1/2" SHEATHING

PURCHASE COMMERCIAL TRUSS TO MEET LOCAL SNOW LOAD CRITERIA

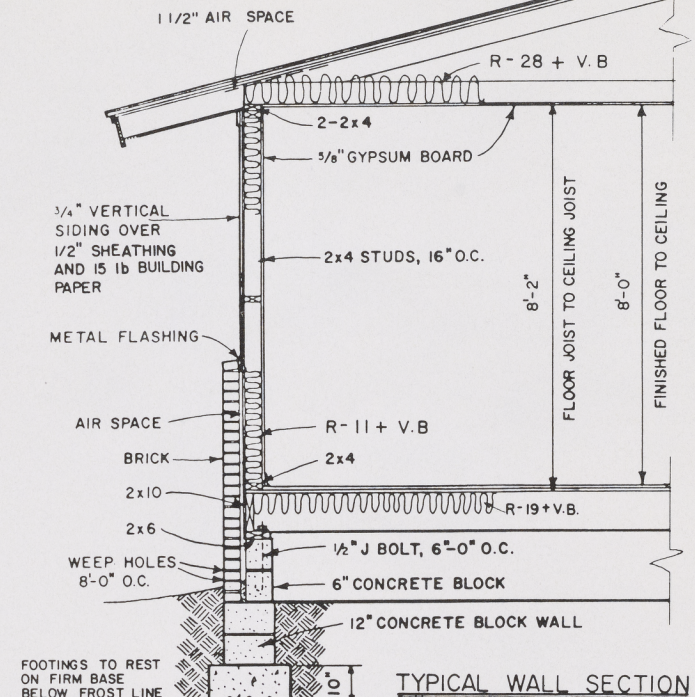
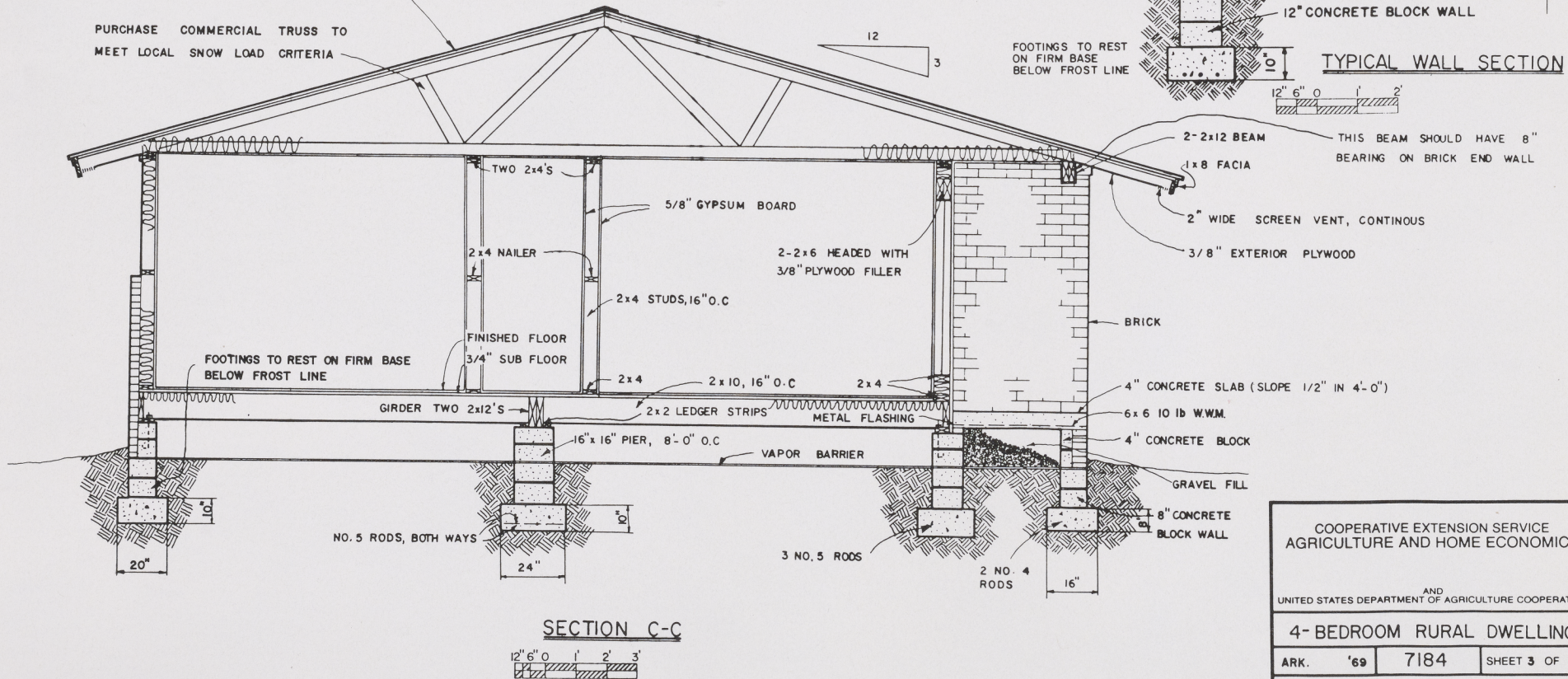

SECTION C-C

TYPICAL WALL SECTION

COOPERATIVE EXTENSION SERVICE AGRICULTURE AND HOME ECONOMICS		
AND UNITED STATES DEPARTMENT OF AGRICULTURE COOPERATING		
4-BEDROOM RURAL DWELLING		
ARK.	'69	7184
REV.	'86	SHEET 3 OF 3

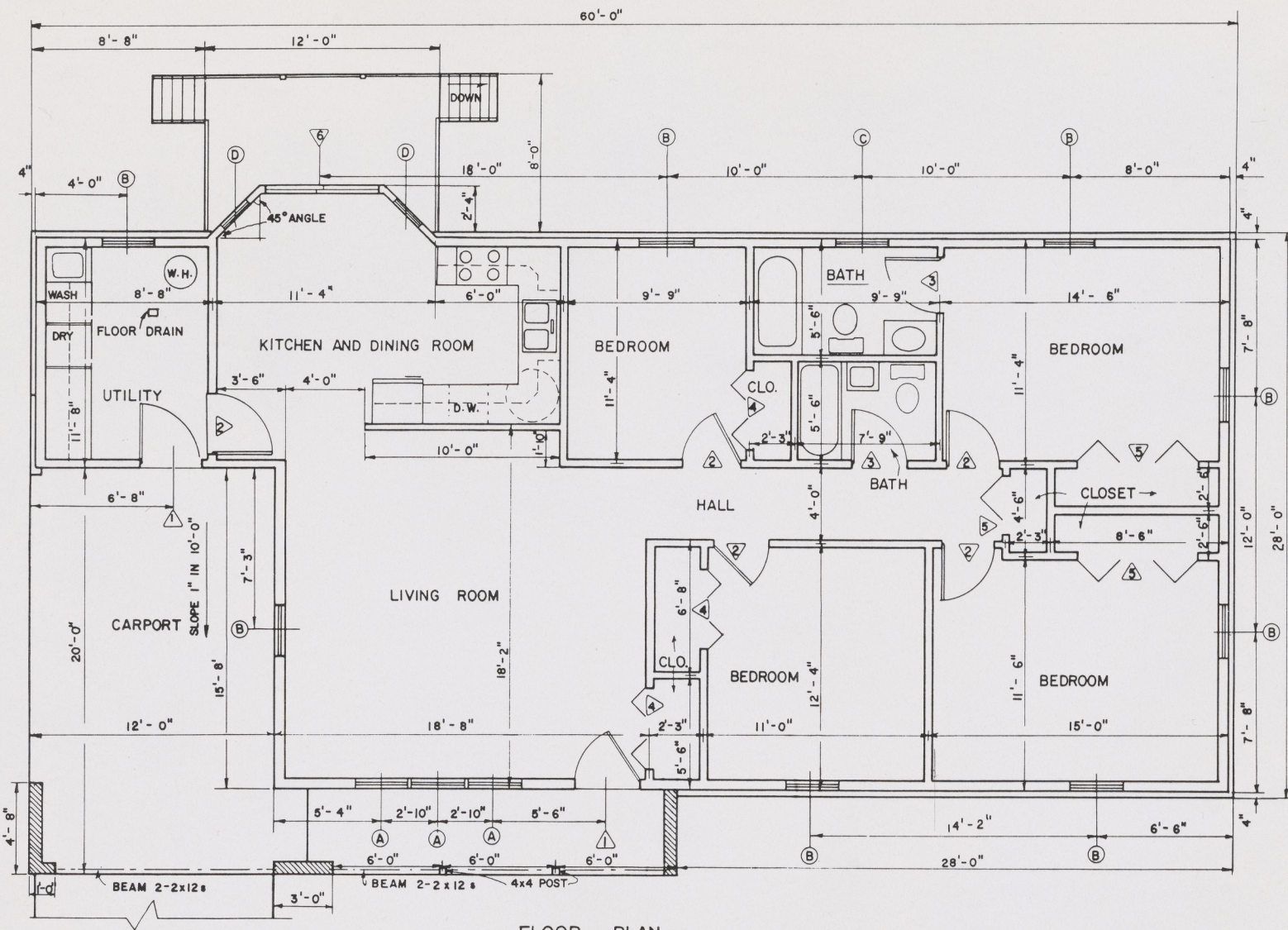

FLOOR PLAN

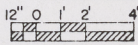

DOOR SCHEDULE			
MARK	SIZE	TYPE	#REQD
1	3'-0" x 6'-8"	SOLID CORE EXTERIOR	2
2	2'-8" x 6'-8"	HOLLOW CORE INTERIOR	5
3	2'-6" x 6'-8"	HOLLOW CORE INTERIOR	2
4	2'-0" x 6'-8"	B1-FOLD	6
5	3'-0" x 6'-8"	B1-FOLD	5
6	6'-0" x 6'-8"	GLASS SLIDING	1

WINDOW SCHEDULE			
MARK	SIZE	TYPE	# REQD.
A	2'-8" x 6'-0"	Combination Fixed Upper w/ Awning Lower	3
B	2'-8" x 4'-0"	Double Hung	8
C	2'-0" x 1'-4"	Awning	1
D	2'-6" x 6'-8"	Fixed Glass	2

USE INSULATED GLASS

COOPERATIVE EXTENSION SERVICE
AGRICULTURE AND HOME ECONOMICS

AND
UNITED STATES DEPARTMENT OF AGRICULTURE COOPERATING

4-BEDROOM RURAL DWELLING

ARK. '69	7184	SHEET 1 OF 3
REV. '86		